



**Nest Learning Thermostat™**  
Installation Guide

# Contents

---

Compatibility .....	3
In the box .....	4
Before you start .....	5
Choose an installation method .....	6
Replacing an existing wired thermostat .....	8
Installing the Nest Thermostat in a new spot .....	20
Cable diagrams .....	32
Nest Labs (Europe) Ltd. Limited Warranty Nest Learning Thermostat™ .....	38

**WARNING:** High voltage. Nest should be installed by a professional

# Compatibility

---

The Nest Learning Thermostat is compatible with almost all central heating systems, including:

- Combi and condensing boilers
- System and heat-only boilers
- Hydronic underfloor systems
- Air source and ground source heat pumps (heating only)
- Zoned systems (one Nest Thermostat per zone)
- Switched live systems
- Low-voltage (dry contact) systems

You don't need Wi-Fi to use the Nest Thermostat, but Wi-Fi is required to control Nest from the Nest apps.



# In the box



Display



Base

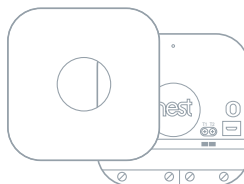

Heat Link

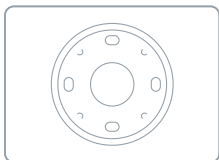

Trim plate



Screws



Welcome Guide, Installation Guide and Warranty

For installations in a new spot only



Power plug

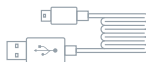

Power cord



Clips

Installation step-by-step



## Before you start

---

### Do I need to install the Nest Thermostat somewhere new?

Many existing wired thermostats are in rooms that are rarely used. The temperature they sense is warmer or cooler than homeowners feel.

So if the old thermostat isn't in a good spot, install Nest somewhere new using the included power plug and cord or using the Stand for Nest Learning Thermostat (sold separately).

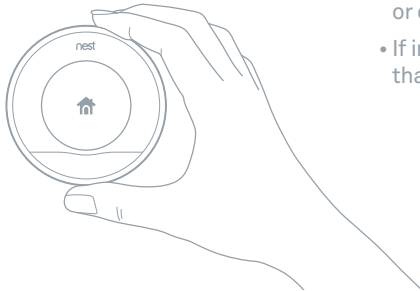

→ On the next page, you'll see options for switching out an existing thermostat or installing Nest in a new spot.

### The Nest Thermostat should be:

- Installed so that it can communicate wirelessly with Heat Link (up to a maximum distance of 30m). The home's construction and arrangement will affect the communication range
- In a room that's used often, so Nest can read the right temperature and the homeowner can easily reach it
- On an interior wall
- Away from drafts
- 1.2 – 1.5m from the floor
- Not behind doors, bookcases or other objects
- If in a zoned system, near the radiator that it's controlling

## Replacing an existing wired thermostat

Choose this installation method if the current thermostat connects to heating cables in the wall and you don't need to move it to a better spot.

→ [Jump to page 8](#)

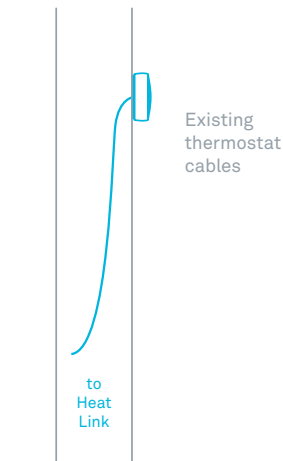

## Installing the Nest Thermostat in a new spot

Choose this installation if the homeowner has a wireless thermostat, no thermostat at all, or a thermostat that needs to be moved to a better spot.

→ Jump to page 20

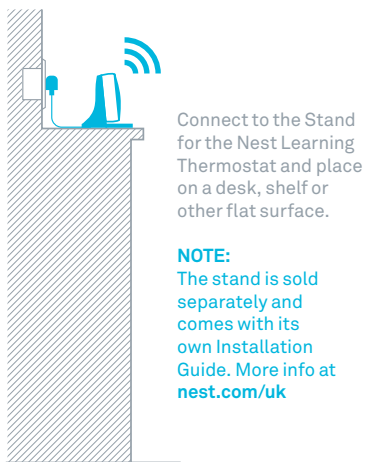
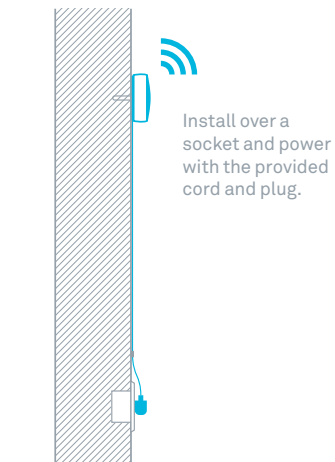

# Replacing an existing wired thermostat

To replace an existing wired thermostat, you'll need to:

1. Install the Heat Link first
2. Remove or configure the programmer
3. Install the Nest Thermostat

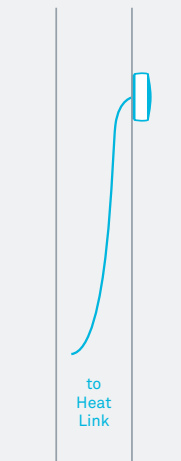



# Install Heat Link

## 1. Switch off mains power

You'll be working with high voltage cables, so protect yourself and the thermostat by turning off the power before you start.



**CAUTION:** High voltage cables

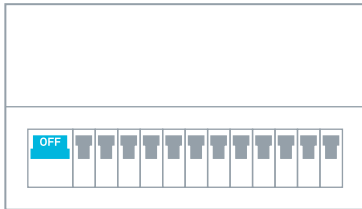

Fuse box

or

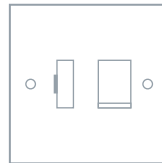

Switch

# Install Heat Link

## 2. Understand the cables

Find the call-for-heat circuit in the heating system.

The circuit may run directly from the thermostat to the boiler or pass through a junction box.

If there's a combi boiler with no junction box, the Heat Link will be connected directly to the boiler's control circuit.

You may need to test each cable to understand its function.

**Make sure you connect the correct cables to the Heat Link to avoid blowing a fuse.**

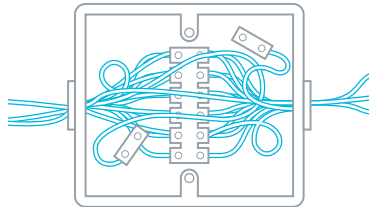

# Install Heat Link

## 3. Choose where you'll install the Heat Link

The Heat Link and Nest Thermostat communicate wirelessly, even if they are also connected by cables. Position the Heat Link such that large metal objects—like the boiler or hot water tank—don't come between it and the thermostat. This can block the wireless signal.

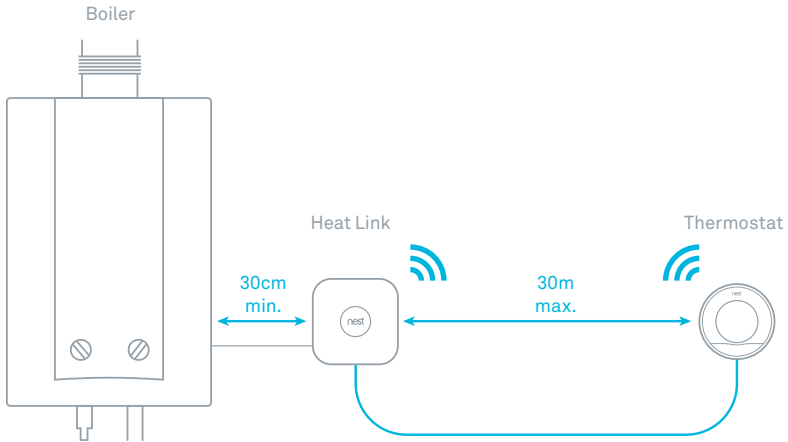

# Install Heat Link

## 4. Run power to the Heat Link

Use a cable to connect the L (live) and N (neutral) connectors on the Heat Link to the L and N connectors on the boiler or junction box. This will power the Heat Link.

If existing controls operate at mains voltage, you can add a jumper cable between live and common. The jumper cable should be 0.75mm<sup>2</sup> and 55mm long (with 8mm of exposed cable at each end).

**WARNING:****DO NOT SKIP**

It's important to install the Heat Link before the Nest Thermostat. Otherwise, high voltage current will irreparably damage the Nest Thermostat.

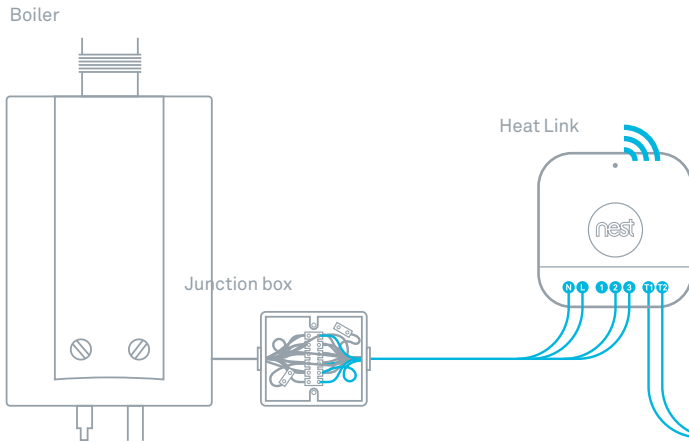

Installation step-by-step

4/5

# Install Heat Link

## 5. Connect the control circuit to the Heat Link

Connect the common and call-for-heat connectors on the boiler or junction box to the 2 (common) and 3 (call-for-heat) connectors on the Heat Link. These cables will control the heating system.

See installation diagrams on page 32.

## 6. Connect the thermostat cables to the Heat Link

Take two cables from the cable bundle that goes to the thermostat and attach them to the T1 and T2 connectors on the Heat Link.

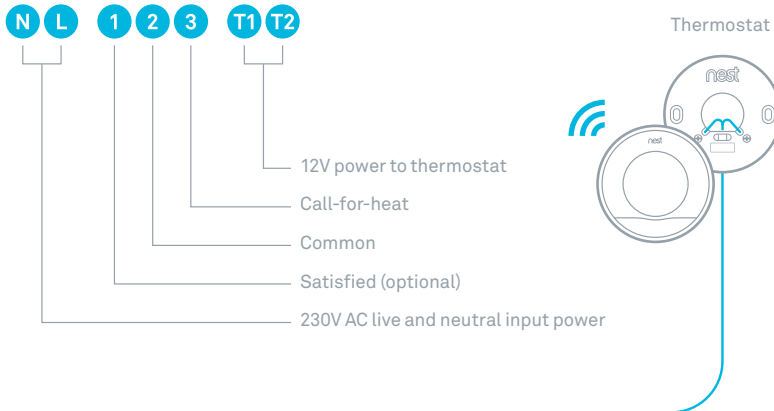

For zoned homes only

## Install Heat Link with a zoned system

If this home has multiple heating zones, each zone valve will need its own Nest Thermostat and Heat Link.

First, disconnect the thermostat cables from the zone valve.

Use a cable to connect the L (live) and N (neutral) connectors on the Heat Link to the L and N connectors on the zone valve.

Connect the common and call-for-heat cables to the 2 (common) and 3 (call-for-heat) connectors on the Heat Link. If necessary, connect the 1 (satisfied) cable from the zone valve to the Heat Link.

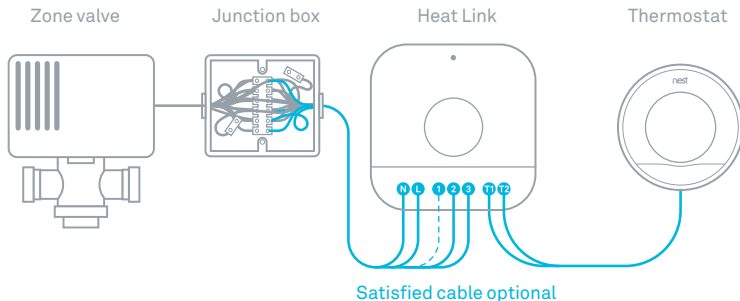

# Install Heat Link

## 7. Attach the Heat Link

Use the included screws to attach Heat Link to a wall near the boiler or junction box, making sure to leave 30cm of space on all sides. When you're done, put the Heat Link cover back on.

Check page 11 for placement info.

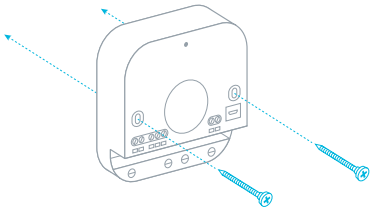

## 8. Configure the programmer

If there's a programmer that controls hot water and heating, set the heating controls to ALWAYS ON. If the programmer only controls heating, then remove it. The Heat Link will control heating in its place.

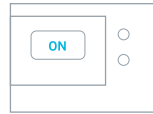

**TIP:** Put this sticker on the programmer to remind homeowners not to adjust it.

attach sticker

# Install thermostat

## 9. Install the base

Remove the old thermostat and attach the Nest base. You can either attach the base directly to the wall or use the included trim plate to cover up marks or route cables that are outside the wall. The trim plate and base snap together and should be screwed to the wall as one piece.

Remember, if the old thermostat isn't in a good place, you should install it in a new spot. Check the placement guidelines on page 5.

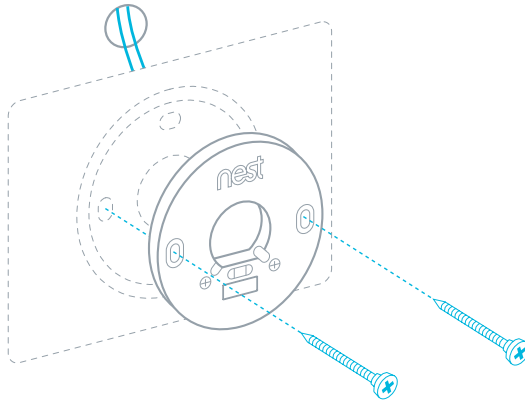



# Install thermostat

## 10. Connect cables

Connect the existing cables to Nest's T1 and T2 connectors. It doesn't matter which cable goes into which connector.



## 11. Attach the display

Press the display onto the base until it clicks into place.

Switch on mains power and Nest will begin setup.

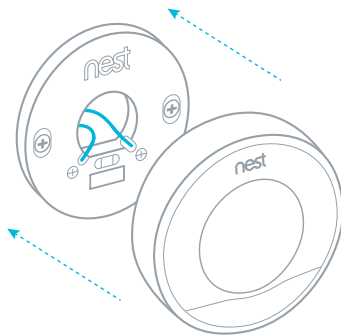

# Install thermostat

## 12. Set up the Nest Thermostat

Just turn the ring and press to select.

During setup, you will:

- Choose a language
- Connect to the home's Wi-Fi network
- Confirm that Heat Link is connected
- If the homeowner used to have a programmer, enter that schedule
- Choose the post code
- Choose an Away temperature

**TIP:** Double check that the programmer has been removed or that its heating channel has been set to ALWAYS ON.



# Install thermostat

---

## 13. Create a Nest Account

Before the homeowner can control Nest from their mobile, tablet or laptop, they need a Nest Account. Tell them to create one at [nest.com/uk/account](https://nest.com/uk/account) or just download the Nest app.

Once the thermostat is connected to Wi-Fi, the Nest app will automatically add it to a Nest Account.

Questions about connecting to a Nest Account? Visit [nest.com/uk/pairing](https://nest.com/uk/pairing)

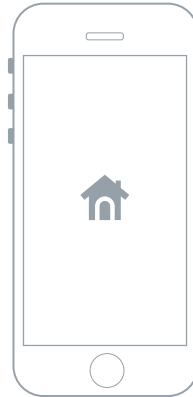

## Installing the Nest Thermostat in a new spot

If you're installing the Nest Thermostat and aren't connecting it to any cables within the wall, then you'll need to:

1. Install the Heat Link first
2. Remove or configure the programmer
3. Attach the Nest Thermostat to the wall
4. Plug the thermostat in with the power plug and cord

**NOTE:** The Stand for the Nest Learning Thermostat is sold separately.

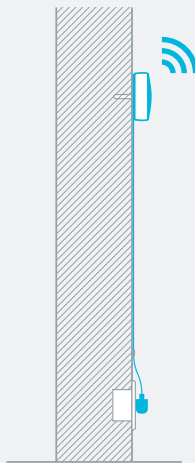

# Install Heat Link

## 1. Switch off mains power

You'll be working with high voltage cables, so protect yourself and the thermostat by turning off the power before you start.



**CAUTION:** High voltage cables

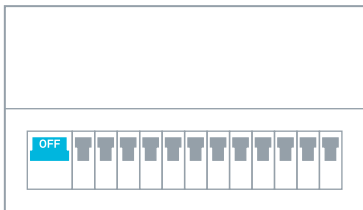

Fuse box

or

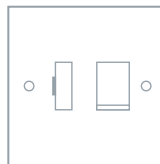

Switch

INSTALL IN A NEW SPOT

Installation step-by-step



# Install Heat Link

## 2. Understand the cables

Find the call-for-heat circuit in the heating system.

The circuit may run directly from the thermostat to the boiler or pass through a junction box.

If there's a combi boiler with no junction box, the Heat Link will be connected directly to the boiler's control circuit.

You may need to test each cable to understand its function.

**Make sure you connect the correct cables to the Heat Link to avoid blowing a fuse.**

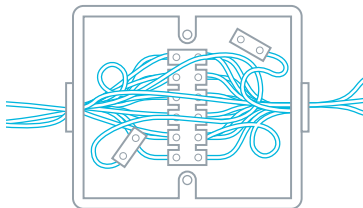

INSTALL IN A NEW SPOT

Installation step-by-step



# Install Heat Link

## 3. Choose where you'll install the Heat Link

The Heat Link and Nest Thermostat communicate wirelessly. Position the Heat Link such that large metal objects—like the boiler or hot water tank—don't come between it and the thermostat. This can block the wireless signal.

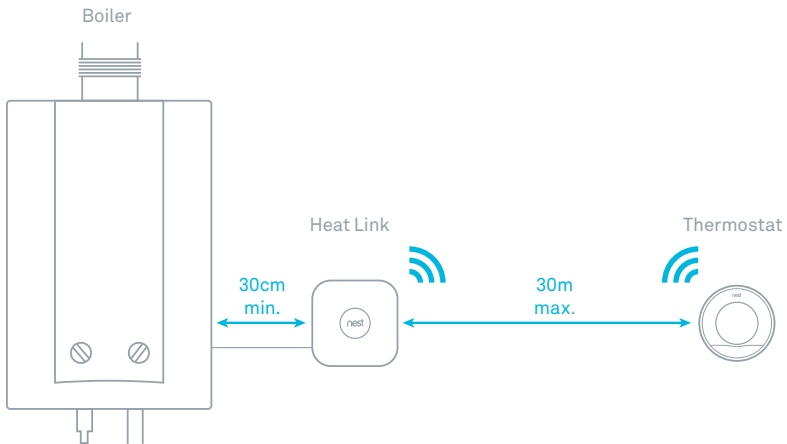

INSTALL IN A NEW SPOT

Installation step-by-step



# Install Heat Link

## 4. Run power to the Heat Link

Use a cable to connect the L (live) and N (neutral) connectors on the Heat Link to the L and N connectors on the boiler or junction box. This will power the Heat Link.

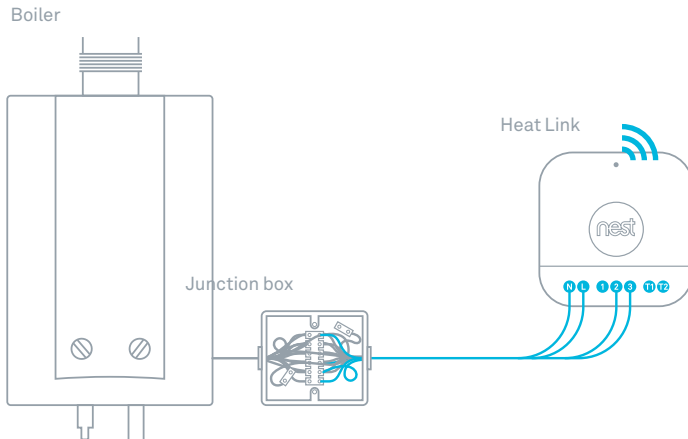

INSTALL IN A NEW SPOT

Installation step-by-step





# Install Heat Link

## 5. Connect the control circuit to the Heat Link

Connect the common and call-for-heat connectors on the boiler or junction box to the 2 (common) and 3 (call-for-heat) connectors on the Heat Link. These cables will control the heating system.

See installation diagrams on page 32.

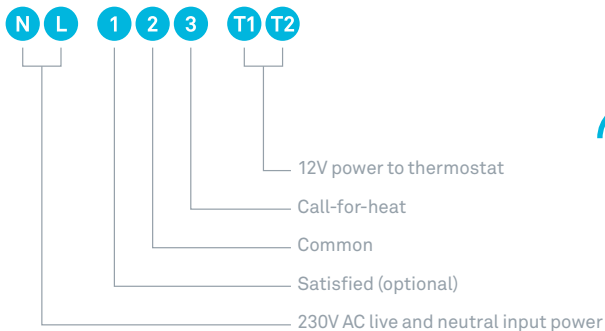

For zoned homes only

## Install Heat Link with a zoned system

If this home has multiple heating zones, each zone valve will need its own Nest Thermostat and Heat Link.

First, disconnect the thermostat cables from the zone valve.

Use a cable to connect the L (live) and N (neutral) connectors on the Heat Link to the L and N connectors on the zone valve.

Connect the common and call-for-heat cables to the 2 (common) and 3 (call-for-heat) connectors on the Heat Link. If necessary, connect the 1 (satisfied) cable from the zone valve to the Heat Link.

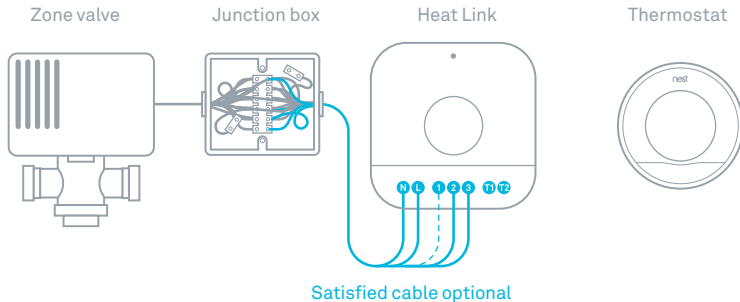

INSTALL IN A NEW SPOT

Installation step-by-step



# Install Heat Link

## 6. Attach the Heat Link

Use the included screws to attach Heat Link to a wall near the boiler or junction box, making sure to leave 30cm space on all sides. When you're done, put the Heat Link cover back on.

Check page 23 for placement info.

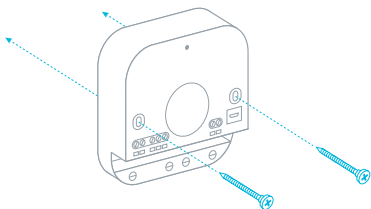

## 7. Configure the programmer

If there's a programmer that controls hot water and heating, set the heating controls to ALWAYS ON. If the programmer only controls heating, then remove it. The Heat Link will control heating in its place.

Lastly, turn the power to the heat back on.

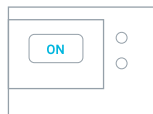

**TIP:** Put this sticker on the programmer to remind homeowners not to adjust it.

See page 15 for sticker.

INSTALL IN A NEW SPOT

Installation step-by-step



# Install thermostat

## 8. Install the Nest Thermostat

Install Nest on a wall using the included power cord, plug and clips. Instructions for installing the Stand for Nest Learning Thermostat (sold separately) come with the stand.

Before attaching the base to the wall, check to make sure the thermostat is within range of the Heat Link.

If you're getting rid of an old thermostat, disable its cables after you remove it, then cover up the hole in the wall.

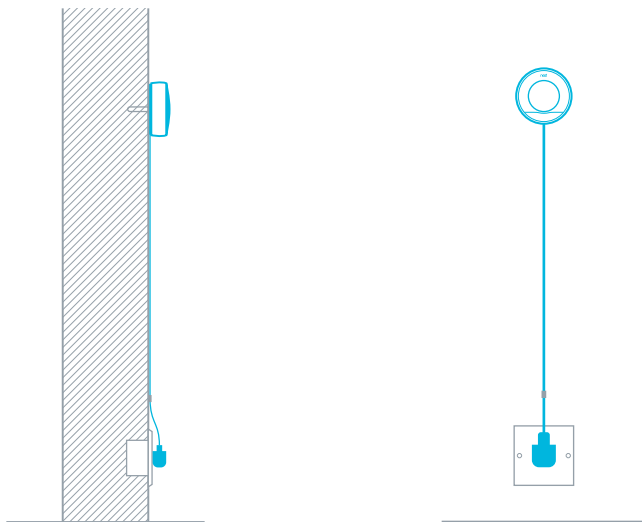

INSTALL IN A NEW SPOT

Installation step-by-step



# Install thermostat

## 9. Install the base

Make sure you install the base above a socket. You can either attach the base directly to the wall or use the trim plate to cover up marks or holes.

The trim plate and base snap together and should be screwed to the wall in one piece.

Check the placement guidelines on page 5 before you install.

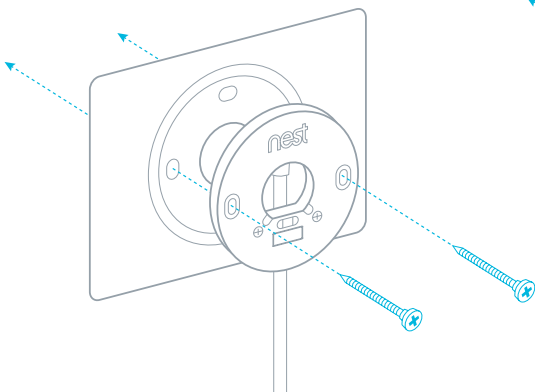

## 10. Attach the display

Press the display onto the base until it clicks into place.

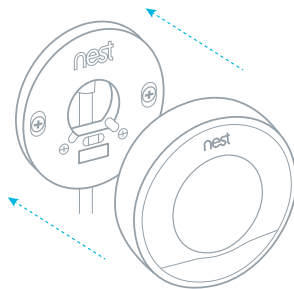

INSTALL IN A NEW SPOT

Installation step-by-step



# Install thermostat

---

## 11. Set up the Nest Thermostat

Just turn the ring and press to select.

During setup, you will:

- Choose a language
- Connect to the home's Wi-Fi network
- Confirm that Heat Link is connected
- If the homeowner used to have a programmer, enter that schedule
- Choose the post code
- Choose an Away temperature

**TIP:** Double check that the programmer has been removed or that its heating channel has been set to ALWAYS ON.



INSTALL IN A NEW SPOT

Installation step-by-step



# Install thermostat

---

## 12. Create a Nest Account

Before the homeowner can control Nest from their mobile, tablet or laptop, they need a Nest Account. Tell them to create one at [nest.com/uk/account](https://nest.com/uk/account) or just download the Nest app.

Once the thermostat is connected to Wi-Fi, the Nest app will automatically add it to a Nest Account.

Questions about connecting to a Nest Account? Visit [nest.com/uk/pairing](https://nest.com/uk/pairing)

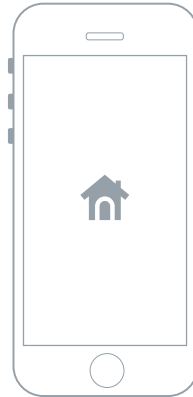

INSTALL IN A NEW SPOT

Installation step-by-step



# Cable diagrams

The following diagrams show you how to install Nest on:

- Switched live systems
- Low voltage (dry contact) systems
- Zone valve systems
- MOMO zone valve systems

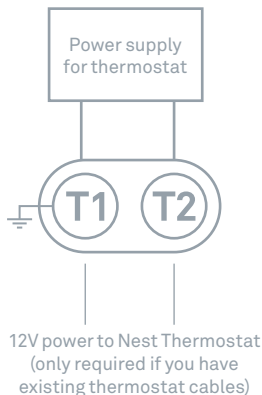
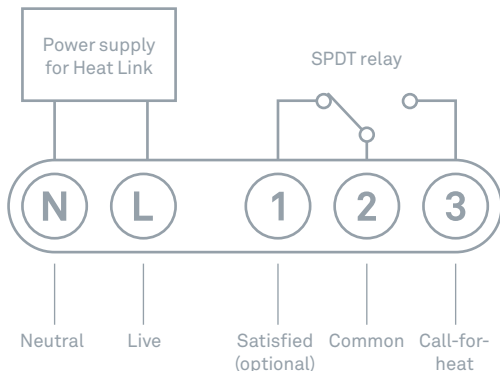

**TIP:** If the call-for-heat circuit is at mains voltage, you can jumper the L (live) and 2 (common) connectors with a 0.75mm<sup>2</sup>, 55mm long jumper cable.





## General specs

---

Connection	Specification	Notes
L	230V AC / 50Hz mains voltage	Required
N	230V AC / 50Hz mains voltage	Required
1	Relay normally closed	3A max.
2	Relay common	3A max.
3	Relay normally open	3A max.
T1	12V DC power output to Nest	Ground
T2	12V DC power output to Nest	Positive

Note: T1 and T2 have no polarity at the thermostat.

**Maximum cable thickness =** 2mm<sup>2</sup>



# Switched Live

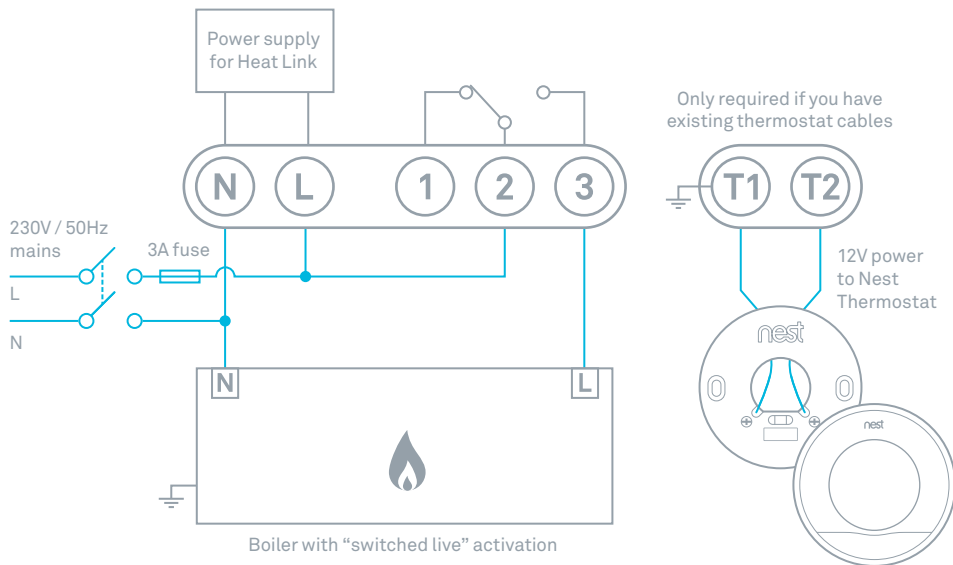

# Low voltage (dry contact)

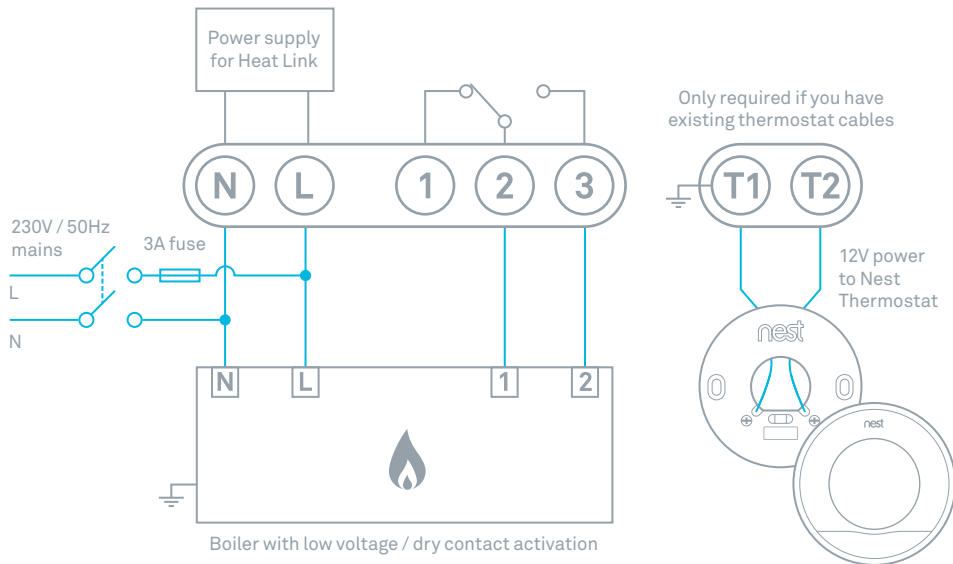

# Boiler with zone valves

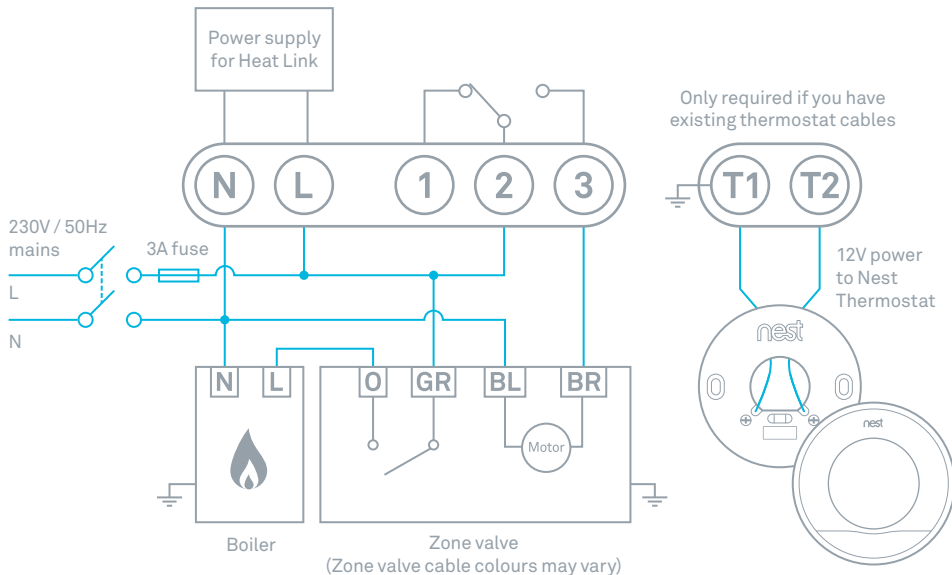

# Boiler with MOMO zone valves

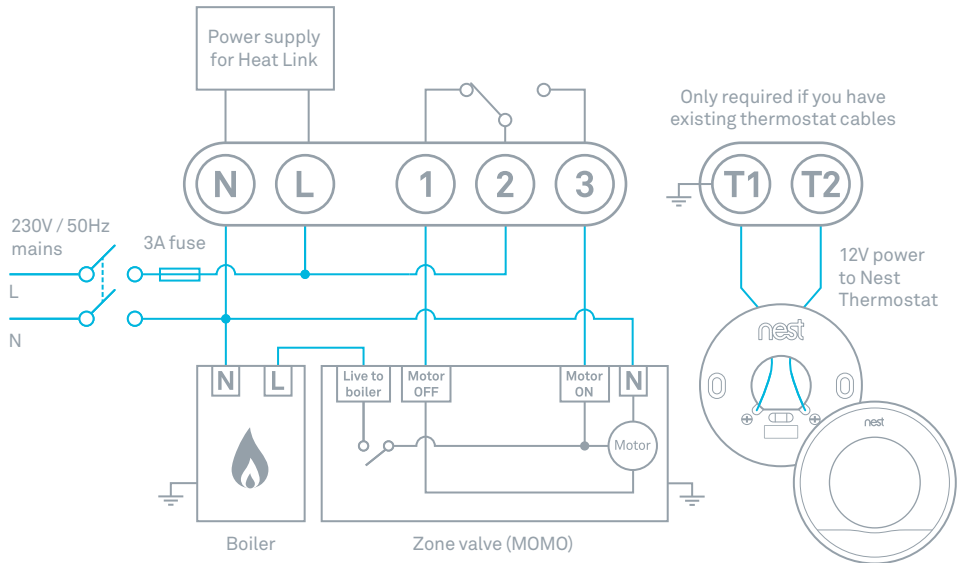

# Nest Labs (Europe) Ltd. Limited Warranty Nest Learning Thermostat™



For online or phone support, visit [nest.com/uk/support](https://nest.com/uk/support)

You can also find answers in the Nest Community at [nest.com/community](https://nest.com/community)



Recycle your old thermostat:  
see [nest.com/uk/responsibility](https://nest.com/uk/responsibility)

Please recycle Nest's 100% recyclable packaging.



## EU Declaration of Conformity

Nest Labs (Europe) Limited hereby declares that this Nest Learning Thermostat is in compliance with the essential requirements and other relevant provisions of Directives 1999/5/EC, 2006/95/EC, 2004/108/EC. A copy of the EU Declaration of Conformity is available at: [nest.com/uk/legal/eudoc](https://nest.com/uk/legal/eudoc)

IMPORTANT INFORMATION ABOUT YOUR RIGHTS AND OBLIGATIONS, AS WELL AS LIMITATIONS AND EXCLUSIONS THAT MAY APPLY TO YOU.

## YOUR RIGHTS AND THIS LIMITED WARRANTY

This Limited Warranty gives you specific legal rights. You may also have other legal rights that vary by state, province or jurisdiction. The disclaimers, exclusions, and limitations of liability under this Limited Warranty will not apply to the extent prohibited by applicable law. For a full description of your legal rights you should refer to the laws applicable in your jurisdiction and you may wish to contact a relevant consumer advisory service. This Limited Warranty is in addition to your legal rights in relation to the Products. This Limited Warranty only applies to Products purchased and used in the European Union.

### 1. WHAT THIS LIMITED WARRANTY COVERS; PERIOD OF COVERAGE

Nest Labs (Europe) Ltd. ("Nest Labs") warrants to the owner of the enclosed product that the product contained in this box ("Product") will be free from defects in materials and workmanship for a period of two (2) years (or one (1) year for Factory Refurbished Products) from the date of delivery following the original retail purchase (the "Warranty Period"). If the Product fails to conform to this Limited Warranty during the Warranty Period, Nest Labs will, at its sole discretion, either (a) repair or replace any defective Product or component; or (b) accept the return of the Product and refund the money actually paid by the original purchaser for the Product. Repair or replacement may be made with a new or refurbished product or components, at Nest Labs' sole discretion. If the Product or a component incorporated within it is no longer available, Nest Labs may replace the Product with a similar product of similar function, at Nest Labs' sole discretion. This is your sole and exclusive remedy for breach of this Limited Warranty. Any Product that has either been repaired or replaced under this Limited Warranty will be covered by the terms of this Limited Warranty for the longer of ninety (90) days from the date of delivery or the remaining Warranty Period. This Limited Warranty is transferable from the original purchaser to subsequent owners, but the Warranty Period will not be extended in duration or expanded in coverage for any such transfer.

### 2. TOTAL SATISFACTION RETURN POLICY

If you are the original purchaser of the Product and you are not satisfied with this Product for any reason, you may return it in its original condition within thirty (30) days of the original purchase and receive a full refund.

### 3. WARRANTY CONDITIONS; HOW TO GET SERVICE IF YOU WANT TO CLAIM UNDER THIS LIMITED WARRANTY

Before being able to claim under this Limited Warranty, the owner of the Product must (a) notify Nest Labs of the intention to claim by visiting [nest.com/uk/support](https://nest.com/uk/support) during the Warranty Period and providing a description of the alleged failure, and (b) comply with Nest Labs' return

shipping instructions. Nest Labs will have no warranty obligations with respect to a returned Product if it determines, in its reasonable discretion after examination of the returned Product, that the Product is an Ineligible Product (defined below). Nest Labs will bear all costs of return shipping to owner and will reimburse any shipping costs incurred by the owner, except with respect to any Ineligible Product, for which owner will bear all shipping costs.

#### **4. WHAT THIS LIMITED WARRANTY DOES NOT COVER**

This warranty does not cover the following (collectively "Ineligible Products"): Products marked as "sample" or sold "AS IS"; or Products that have been subject to: (a) modifications, alterations, tampering, or improper maintenance or repairs; (b) handling, storage, installation, testing, or use not in accordance with the User's Guide or other instructions provided by Nest Labs; (c) abuse or misuse of the Product; (d) breakdowns, fluctuations, or interruptions in electric power or the telecommunications network; or (e) Acts of God, including lightning, flood, tornado, earthquake, or hurricane. This warranty does not cover consumable parts, including batteries, unless damage is due to defects in materials or workmanship of the Product, or software (even if packaged or sold with the product). Nest Labs recommends that you use only authorized service providers for maintenance or repair. Unauthorized use of the Product or software can impair the Product's performance and may invalidate this Limited Warranty.

#### **5. DISCLAIMER OF WARRANTIES**

EXCEPT AS STATED ABOVE IN THIS LIMITED WARRANTY, AND TO THE MAXIMUM EXTENT PERMITTED BY APPLICABLE LAW, NEST LABS DISCLAIMS ALL EXPRESS, IMPLIED, AND STATUTORY WARRANTIES AND CONDITIONS WITH RESPECT TO THE PRODUCT, INCLUDING THE IMPLIED WARRANTIES OF MERCHANTABILITY, AND FITNESS FOR A PARTICULAR PURPOSE. TO THE MAXIMUM EXTENT PERMITTED BY APPLICABLE LAW, NEST LABS ALSO LIMITS THE DURATION OF ANY IMPLIED WARRANTIES OR CONDITIONS TO THE DURATION OF THIS LIMITED WARRANTY.

#### **6. LIMITATION OF DAMAGES**

IN ADDITION TO THE ABOVE WARRANTY DISCLAIMERS, IN NO EVENT WILL NEST LABS BE LIABLE FOR ANY CONSEQUENTIAL, INCIDENTAL, EXEMPLARY, OR SPECIAL DAMAGES, INCLUDING ANY DAMAGES FOR LOST DATA OR LOST PROFITS, ARISING FROM OR RELATING TO THIS LIMITED WARRANTY OR THE PRODUCT, AND NEST LABS' TOTAL CUMULATIVE LIABILITY ARISING FROM OR RELATED TO THIS LIMITED WARRANTY OR THE PRODUCT WILL NOT EXCEED THE AMOUNT ACTUALLY PAID FOR THE PRODUCT BY THE ORIGINAL PURCHASER.

#### **7. LIMITATION OF LIABILITY**

IF YOU CHOOSE TO USE THEM, ONLINE SERVICES OFFERED BY NEST LABS, INC., A US AFFILIATE OF NEST LABS ("SERVICES") PROVIDE

YOU INFORMATION ("PRODUCT INFORMATION") REGARDING YOUR NEST PRODUCTS OR OTHER PERIPHERALS CONNECTED TO YOUR PRODUCTS ("PRODUCT PERIPHERALS"). THE TYPE OF PRODUCT PERIPHERALS THAT MAY BE CONNECTED TO YOUR PRODUCT MAY CHANGE FROM TIME TO TIME. WITHOUT LIMITING THE GENERALITY OF THE DISCLAIMERS ABOVE, ALL PRODUCT INFORMATION IS PROVIDED FOR YOUR CONVENIENCE; "AS IS"; AND "AS AVAILABLE". NEST LABS OR ITS AFFILIATE DOES NOT REPRESENT, WARRANT, OR GUARANTEE THAT PRODUCT INFORMATION WILL BE AVAILABLE, ACCURATE, OR RELIABLE OR THAT PRODUCT INFORMATION OR USE OF THE SERVICES OR PRODUCT WILL PROVIDE SAFETY IN YOUR HOME. YOU USE ALL PRODUCT INFORMATION, THE SERVICES, AND THE PRODUCT AT YOUR OWN DISCRETION AND RISK. YOU WILL BE SOLELY RESPONSIBLE FOR (AND NEST LABS AND ITS AFFILIATE DISCLAIM) ANY AND ALL LOSS, LIABILITY, OR DAMAGES, INCLUDING TO YOUR WIRING, FIXTURES, ELECTRICITY, HOME, PRODUCT, PRODUCT PERIPHERALS, COMPUTER, MOBILE DEVICE, AND ALL OTHER ITEMS AND PETS IN YOUR HOME, RESULTING FROM YOUR USE OF THE PRODUCT INFORMATION, SERVICES, OR PRODUCT. PRODUCT INFORMATION PROVIDED BY THE SERVICES IS NOT INTENDED AS A SUBSTITUTE FOR DIRECT MEANS OF OBTAINING THE INFORMATION.

#### **8. VARIATIONS THAT MIGHT APPLY TO THIS LIMITED WARRANTY**

Some jurisdictions do not allow limitations on how long an implied warranty lasts or specific exclusions, so some of the limitations set out above may not apply to you.

#### **9. CONTACT INFORMATION**

Please direct any questions about this Limited Warranty to Nest Labs (Europe) Ltd. at the address located at: [nest.com/uk/contact](https://www.nest.com/uk/contact).

64-30-0017-GB-A

